

型号/Type no: HTO-0837L

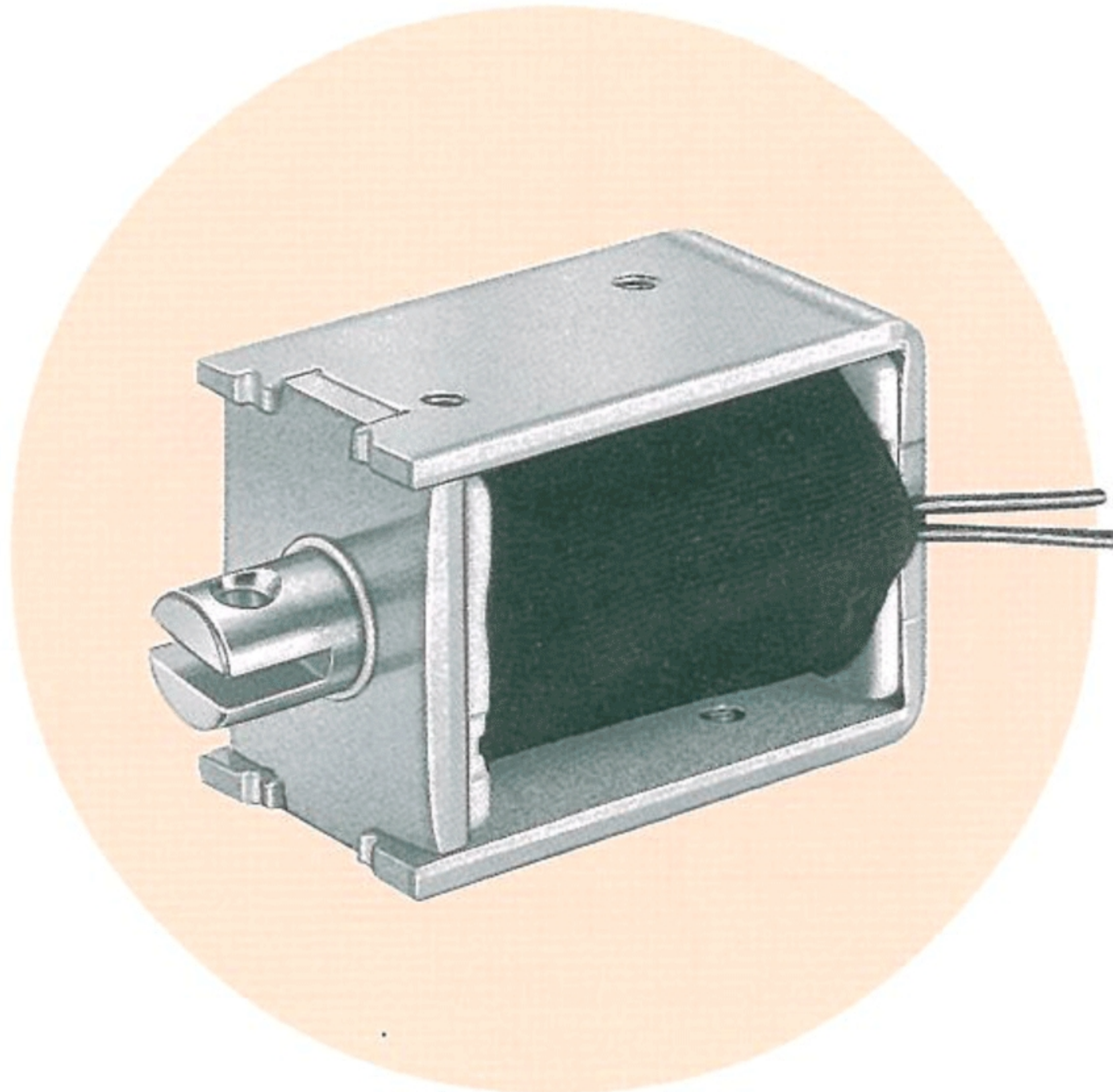

Plunger Weight 可动铁心重量 : 12g
Total Weight 总重量 : 96g

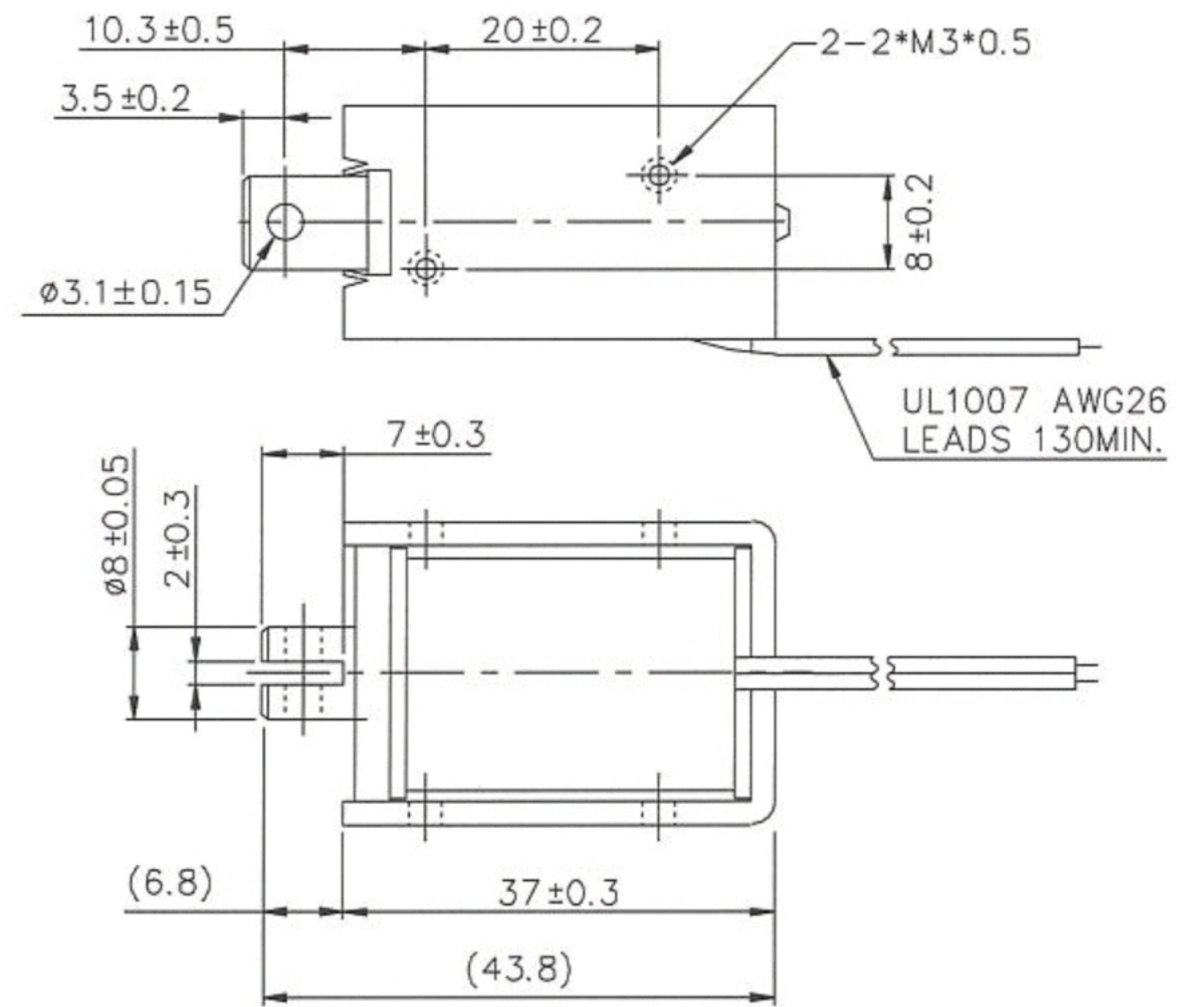

Shown Energized 通电状态 UNIT 单位: mm

STROKE Vs FORCE 行程 / 吸引力

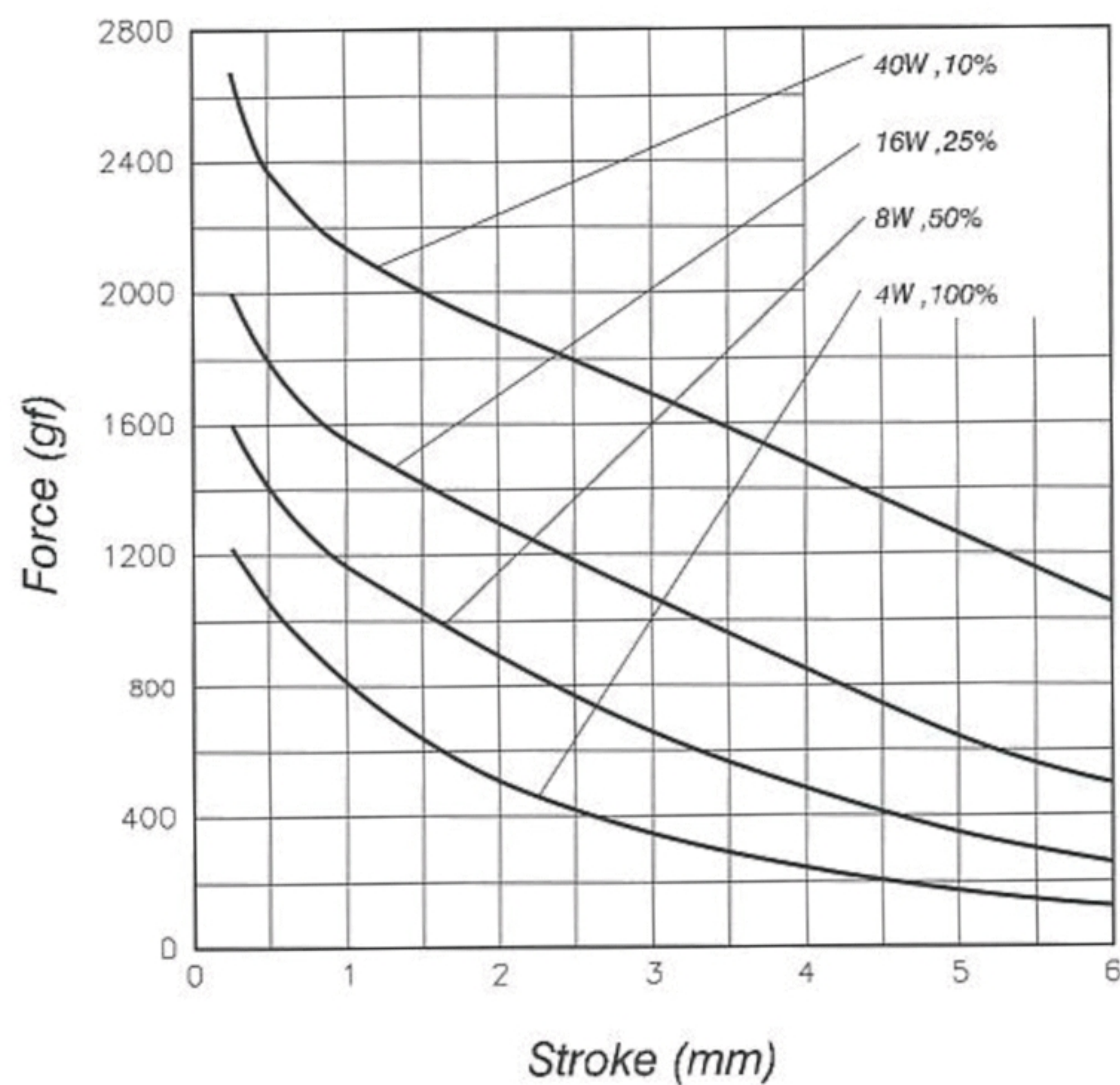

AMPERE-TURNS Vs FORCE 安-匝 / 吸引力

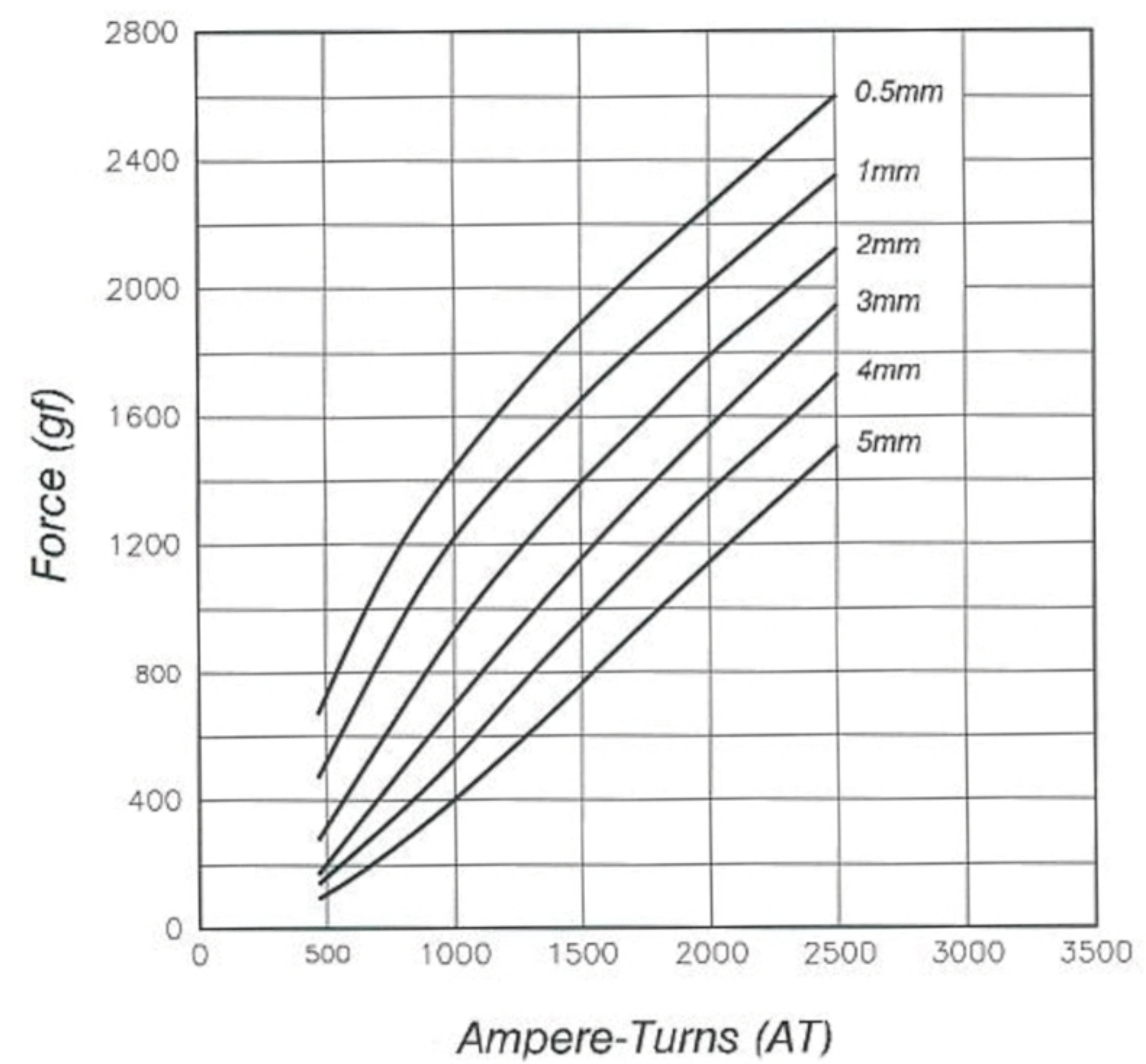

COIL DATA 线圈资料

Duty cycle (%) = $\frac{\text{"ON" time}}{\text{"ON" time} + \text{"OFF" time}} \times 100\%$		Continuous (100%)	Or less (50%)	Or less (25%)	Or less (10%)	
作动周期(%) = $\frac{\text{ON 时间}}{\text{ON 时间} + \text{OFF 时间}} \times 100\%$		连续 (100%)	间断 (50%)	间断 (25%)	间断 (10%)	
MAX. "on" time in seconds 最大 ON 时间 (秒)		∞	100	36	7	
Watts at 20°C 瓦特数(W) (在 20°C)		4	8	16	40	
Ampere-turns at 20°C AT 值 (在 20°C)		666	941	1332	2106	
Type no.	Resistance (20°C) Ω ± 10%	No. turns	Volts DC 电压			
型号	阻值 (Ω) ± 10%	绕线圈数				
HTO-0837S06AA	9	1000	6	8.5	12	19
HTO-0837S12AA	36	2000	12	17	24	38
HTO-0837S24AA	144	4000	24	34	48	76
HTO-0837S48AA	576	7540	48	68	96	152